

Problems of the Day 2019

Day
1

- 1** What fraction of each rectangle is shaded?

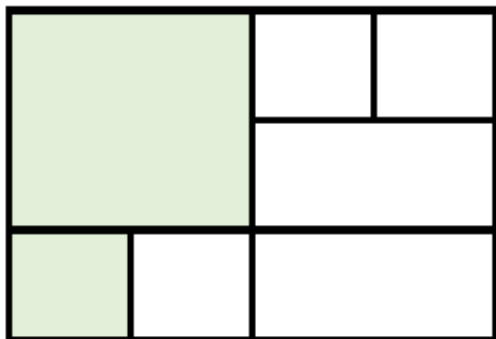
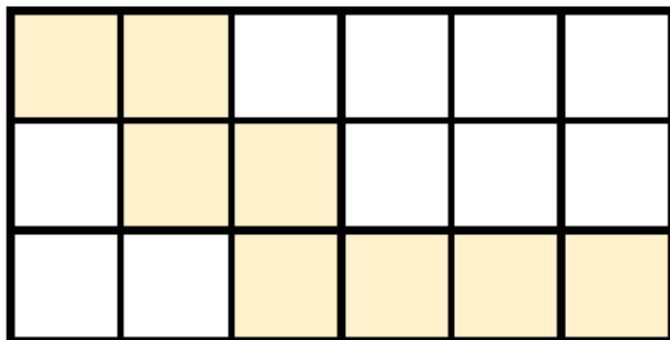

- 2** Work out the following fraction calculations.

(a) $\frac{3}{6} + \frac{1}{2}$

(b) $\frac{2}{5} + \frac{7}{15} + \frac{3}{5} + \frac{8}{15}$

(c) $1 - \frac{1}{5} - \frac{3}{10}$

Problems of the Day 2019

Day
2

- 1** A shape is made up of two equilateral triangles and a square.

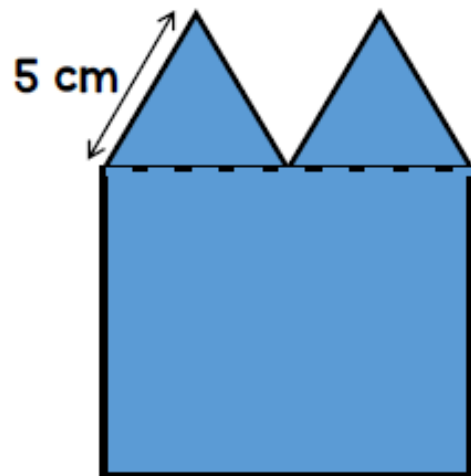

What is the perimeter of the shape?

- 2** The perimeter of the pentagon is 25 cm.

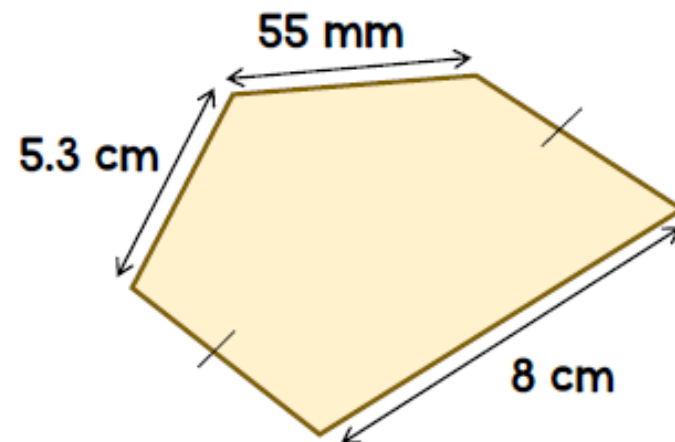

Find the missing lengths.

Problems of the Day 2019

Day
3

1 Helen has £400

She spends $\frac{1}{10}$ of the money on a new toaster.

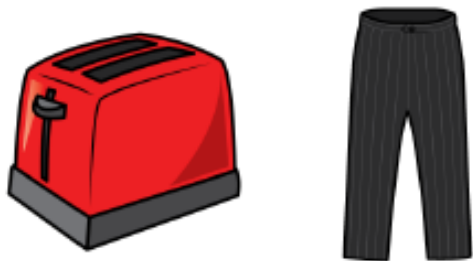

She spends $\frac{1}{8}$ of the amount left on a pair of trousers.

Which item costs the most?

2 $\frac{3}{8}$ of people watching a play are adults.

The rest of the people watching are children.

There are 32 more children than adults watching the play.

How many people are watching the play in total?

- 1 Usman saves 10p and 50p coins in his money box.



He has saved £12.70

32 of the coins in the money box are 10p coins.

How many 50p coins are in the box?

- 2 The table shows the number of loaves of bread sold in a shop each week in February.

Week	Number of loaves sold
1 st Week	480
2 nd Week	400
3 rd Week	70
4 th Week	250

Which week did the shop sell $\frac{1}{3}$ of the total number of loaves of bread sold in February?

1 A bucket holds 5 litres of water.

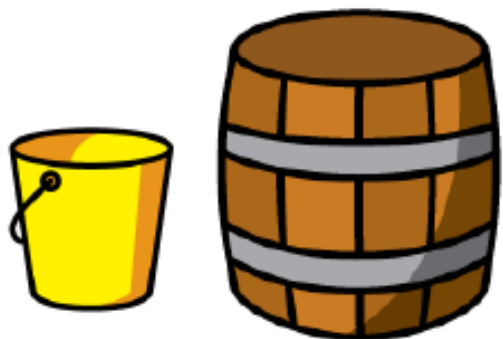

Yasmin uses 7 and a quarter buckets to fill the barrel with water.

How much water does the barrel hold?

2 Leah has a piece of ribbon 4.8 metres long.



She cuts a 1.2 m piece of ribbon off from the end.

She cuts the remaining ribbon into 2 pieces of equal length.

How long are the pieces of ribbon?

Problems of the Day 2019

Day 1

1 What fraction of each rectangle is shaded?

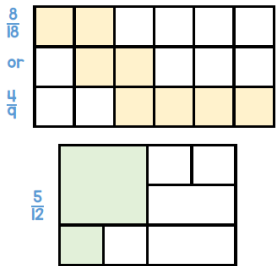

2 Work out the following fraction calculations.

(a) $\frac{3}{6} + \frac{1}{2} = 1$

(b) $\frac{2}{5} + \frac{7}{15} + \frac{3}{5} + \frac{8}{15} = 2$

(c) $1 - \frac{1}{5} - \frac{3}{10} = \frac{1}{2}$



Problems of the Day 2019

Day 2

1 A shape is made up of two equilateral triangles and a square.

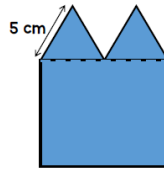

What is the perimeter of the shape?
The perimeter of the shape is 50 cm.

2 The perimeter of the pentagon is 25 cm.

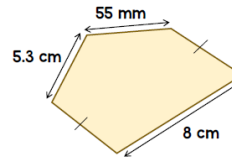

Find the missing lengths.
Each of the missing lengths are 31 mm or 3.1 cm.



Problems of the Day 2019

Day 3

1 Helen has £400
She spends $\frac{1}{10}$ of the money on a new toaster.



She spends $\frac{1}{8}$ of the amount left on a pair of trousers.

Which item costs the most?
The trousers cost the most They cost £45 and the toaster only costs £40

2 $\frac{3}{8}$ of people watching a play are adults.

The rest of the people watching are children.

There are 32 more children than adults watching the play.

How many people are watching the play in total?

128 people are watching the play in total.



Problems of the Day 2019

Day 4

1 Usman saves 10p and 50p coins in his money box.



He has saved £12.70

32 of the coins in the money box are 10p coins.

How many 50p coins are in the box?
There are 19 50p coins in the box.

2 The table shows the number of loaves of bread sold in a shop each week in February.

Week	Number of loaves sold
1 st Week	480
2 nd Week	400
3 rd Week	70
4 th Week	250

Which week did the shop sell $\frac{1}{3}$ of the total number of loaves of bread sold in February?
2nd week.



Problems of the Day 2019

Day 5

1 A bucket holds 5 litres of water.



Yasmin uses 7 and a quarter buckets to fill the barrel with water.

How much water does the barrel hold?
The barrel holds 36 and a quarter litres of water.

2 Leah has a piece of ribbon 4.8 metres long.



She cuts a 1.2 m piece of ribbon off from the end.

She cuts the remaining ribbon into 2 pieces of equal length.

How long are the pieces of ribbon?
The pieces of ribbon are 1.8 m long.

